

hydrogap® sa

hydroflash®

accessories

AIR BARRIER DRAINABLE HOUSEWRAP PROTECTION

installation instructions

800.523.5261
techsupport@obdyke.com

BENJAMIN OBDYKE
roof & wall products

AIR BARRIER DRAINABLE HOUSEWRAP INSTALLATION INSTRUCTIONS

hydrogap® sa

hydroflash®

accessories

REVIEW PRIOR TO INSTALLATION OF HYDROGAP SA & FLASHINGS

Store HydroGap® SA above 45° F in a conditioned space prior to cold weather installation.

Prepare the sheathing to be free of dust and debris. Cleaning with a push broom or air compressor is recommended.

A primer is not required on most clean, dry surfaces when exterior surfaces are above 25° F.

HydroGap® SA is a self-adhered product and does not require any fasteners during installation. Staples/cap-fasteners may be used to temporarily fasten as you roll out each course.

The continuous acrylic adhesive can be repositioned on sheathing to verify a smooth installation with minimum wrinkles. However, be sure the adhesive does NOT make contact with itself.

HydroGap® SA should be installed shingle lap fashion (ie. begin at the base of the wall assembly).

Extend the housewrap a minimum 2 inches over sill plate.

Overlap all horizontal seams by at least 4 inches, all vertical seams by at least 6 inches, and corners by 12 inches.

Be sure that the housewrap and flashing installation provide for positive drainage to the exterior of the assembly.

Do not allow the housewrap to be exposed to sunlight in excess of 120 days prior to the installation of cladding.

You must use firm and even pressure when applying HydroGap® SA to activate the adhesive. To apply even pressure and conform around the spacers, we recommend using the following: a floor squeegee, floor roller, firm push broom, or a larger hand applicator.

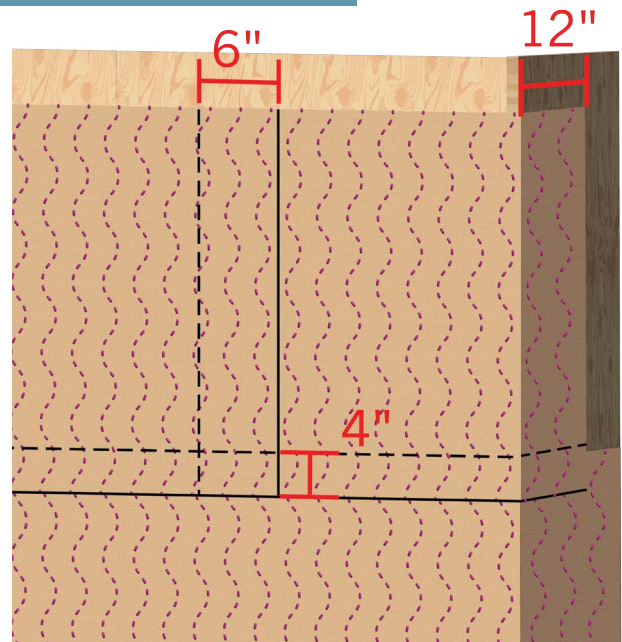

It is normal to see a few spacers fall off during the application of surface pressure. THIS WILL NOT IMPACT THE PERFORMANCE.

Flash wall penetrations (outlets, exhaust vents, etc.) with proper shingling technique to maintain drainage to the exterior .

Flash windows and doors according to building code requirements. Surface should be clean and dry. All self-adhered flashing must be adhered using a hand applicator. HydroFlash® should be stored inside or in a conditioned space prior to installing in cold temperatures.

Install windows and doors per manufacturer's installation instructions.

Tape all tears and holes that may have been inadvertently introduced during the construction process.

HydroGap® SA can be installed in any direction and still maintain its performance characteristics.

AIR BARRIER DRAINABLE HOUSEWRAP INSTALLATION INSTRUCTIONS

hydrogap® sa

hydroflash®

accessories

HYDROGAP SA INSTALLATION WALL ASSEMBLY

BEGINNING COURSES

Using a chalk line, establish a “control line” to use as a guide for the top edge of the first courses of HydroGap® SA. Follow this control line as you install the first course to minimize wrinkles and ensure maximum contact with the sheathing.

Starting from the upper corner of the top half of the split release liner, peel 24 inches of the liner to expose the adhesive. Place the exposed adhesive corner to the edge of the “control line” to install the first course. OPTION: you may fasten the exposed corner with a staple or cap fastener to hold in place as you continue with the next step.

Once the corner is firmly in place, pull the rest of the top half of the release liner at a 45° angle as you work to unroll the wrap along the wall. Verify alignment and begin to smooth starting from the center of HydroGap SA and work to the edges. Adhesive can be repositioned on the sheathing to verify maximum contact and reduce wrinkles and air pockets

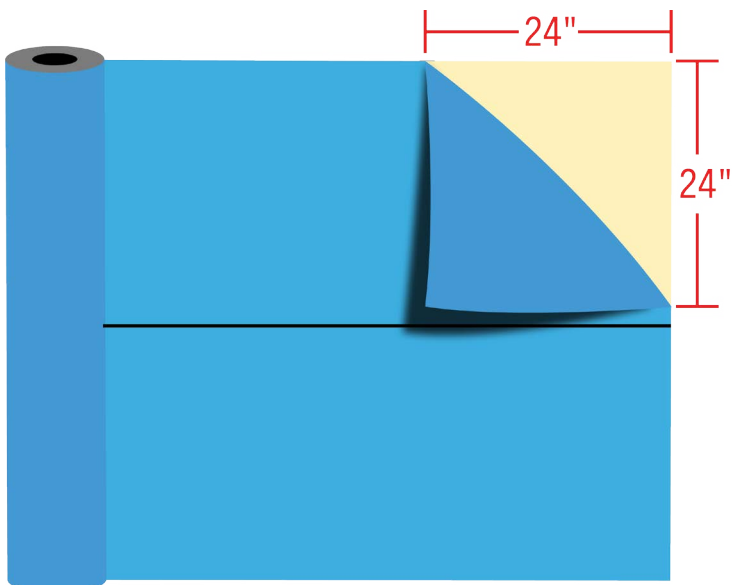

BACK OF HydroGap SA

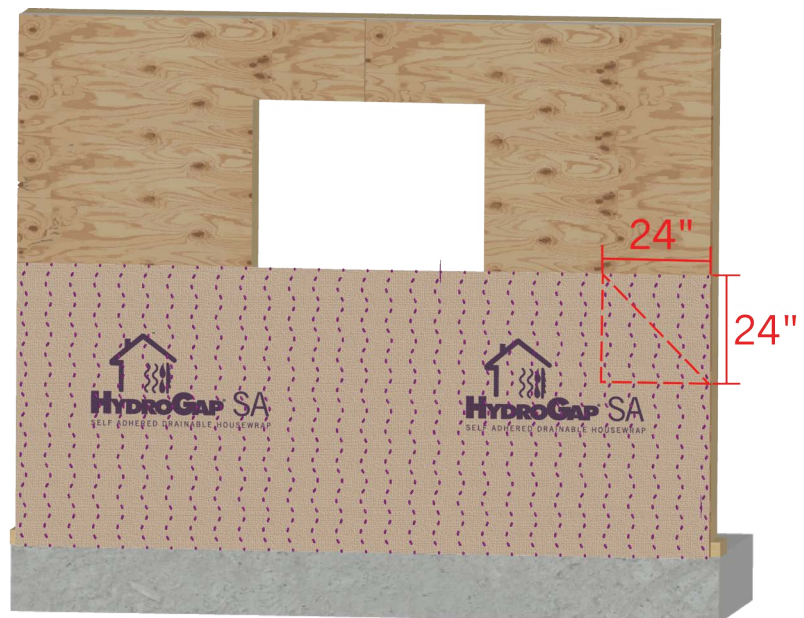

AIR BARRIER DRAINABLE HOUSEWRAP INSTALLATION INSTRUCTIONS

hydrogap® sa

hydroflash®

accessories

HYDROGAP SA LAYOUT & INSTALLATION

HOUSEWRAP LAYOUT/INSTALLATION

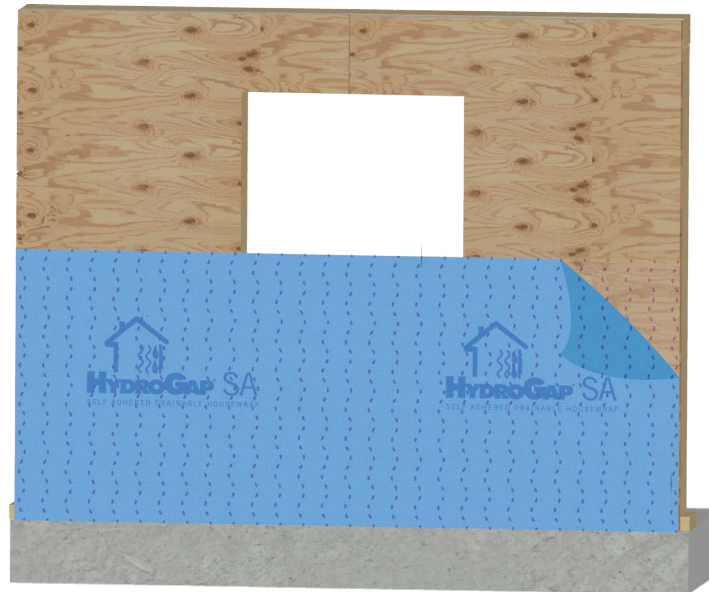

Once the course is in place, use a j-roller or other application tool to apply firm, even pressure to fully adhere the wrap to the sheathing

Repeat the same steps for consecutive courses, shingling over as you work up the wall. Overlap requirements are as follows: horizontal overlaps 4 inches, vertical overlaps 6 inches, and 12 inches inside or around corners.

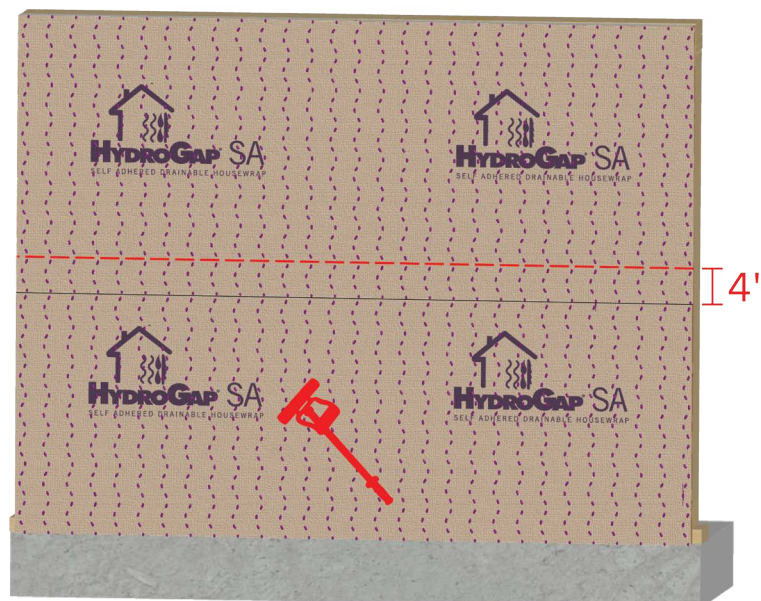

AIR BARRIER DRAINABLE HOUSEWRAP INSTALLATION INSTRUCTIONS

hydrogap® sa

hydroflash®

accessories

AIR BARRIER DRAINABLE WINDOW ASSEMBLY

“Fold-In” Window Installation

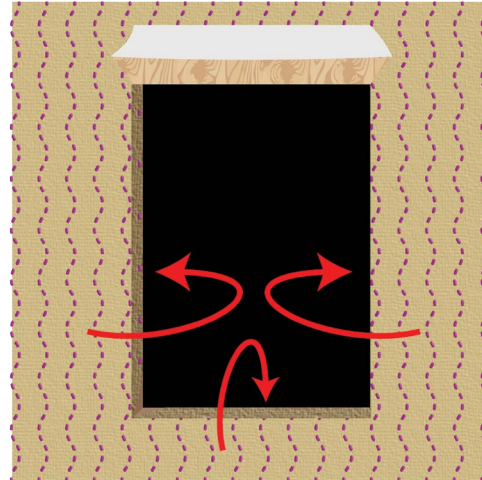
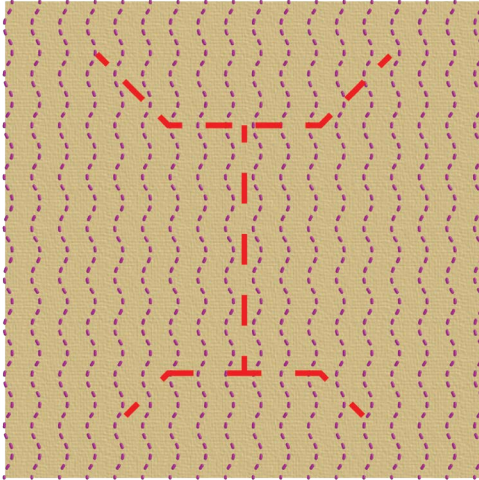

When wrapping the structure in HydroGap SA, avoid rolling/applying pressure to the top of windows and doors, this will ensure the proper shingle lapping of self-adhered flashing tape

At each window open, cut an “I” shape into the housewrap. Cut housewrap above the top corners 45 degrees away from the window opening to account for flashing width.

Fold side flaps into rough opening. Cut and apply pressure allowing the adhesive to stick to the jambs.

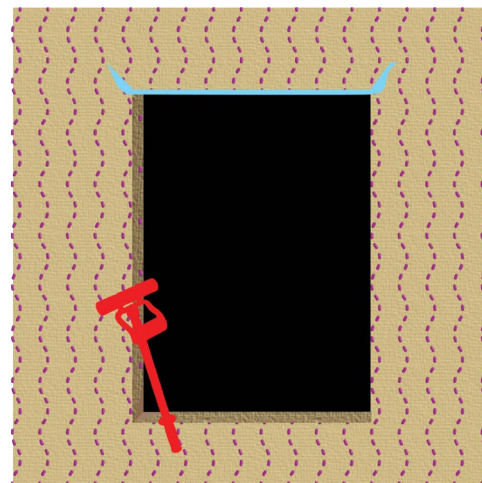
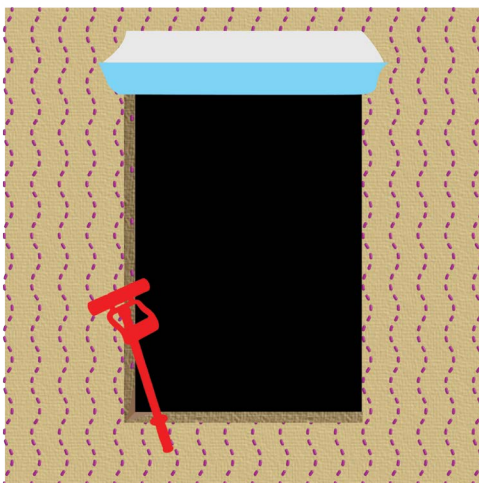

Fold up top trapezoid shape “flap” and stick a strip of the adhesive backer underneath, keeping the flap from sticking to the sheathing

Using a roller or hand applicator, apply HydroFlash® to the exterior of the sill, extending 6" past each jamb.

AIR BARRIER DRAINABLE HOUSEWRAP INSTALLATION INSTRUCTIONS

hydrogap® sa

hydroflash®

accessories

AIR BARRIER DRAINABLE WINDOW ASSEMBLY

“Fold-In” Window Installation

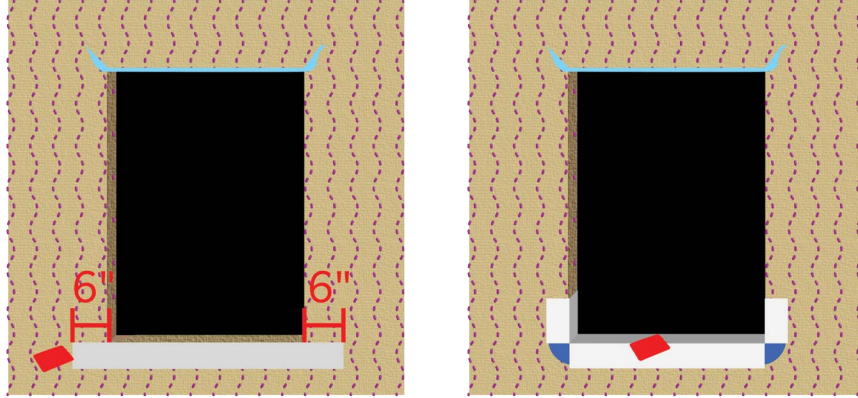

WINDOW SILL DETAILS

Bow tie detail

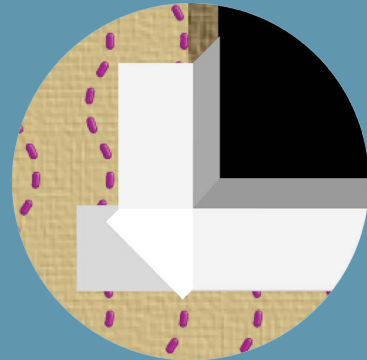
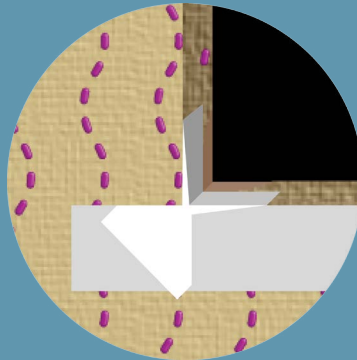
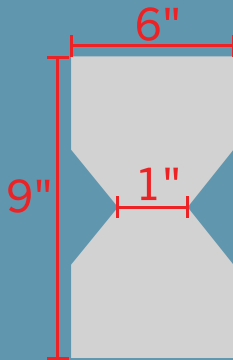

- (optional) Install sloped sill or back dam (optimal slope .25”), except when using approved pre-manufactured sill pan.
- To properly flash the sill, cut and install corner patch flashing or use HydroCorners.
- Install HydroFlash 9” to extend at least 6 inches up the side of each jamb inside window opening.
- To use 6” HydroFlash at the sill, two pieces must be used: one piece flush with the sill edge; and the other folded into the sill. All flashing should be installed using firm pressure, with either a hand applicator or roller.

HydroCorner Detail

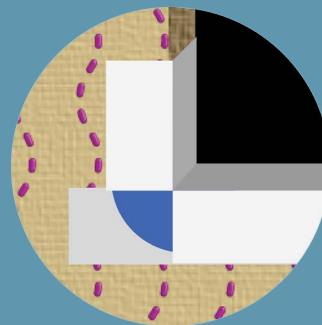
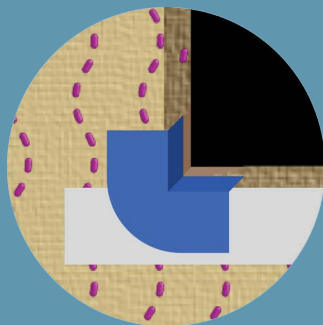

- To use HydroCorners instead of patches, place a HydroCorner in each sill corner and fasten in place with a staple. Install HydroFlash 9” to extend at least 6 inches up the inside of each jamb inside the window opening.

AIR BARRIER DRAINABLE HOUSEWRAP INSTALLATION INSTRUCTIONS

hydrogap® sa

hydroflash®

accessories

AIR BARRIER DRAINABLE WINDOW ASSEMBLY

“Fold-In” Window Installation

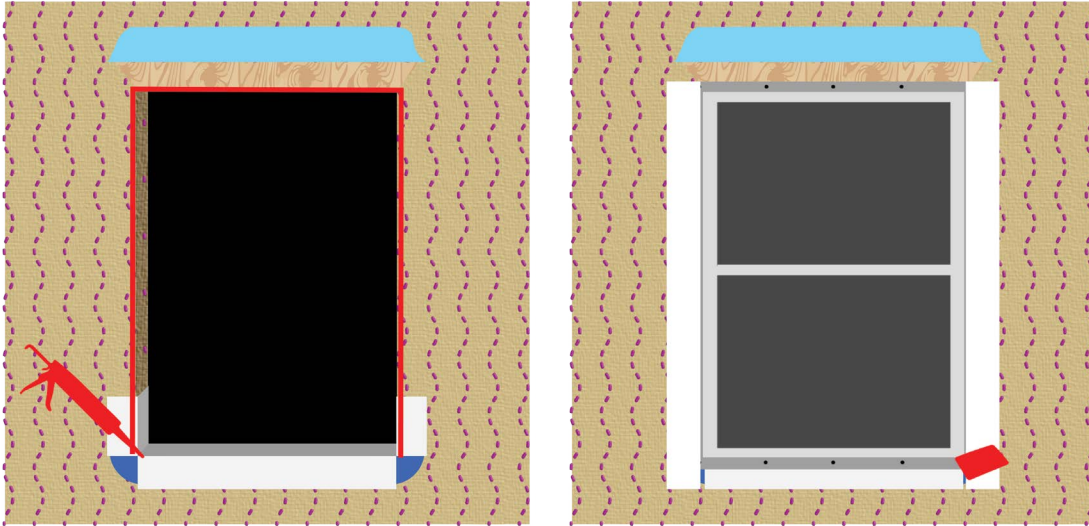

- Apply caulk/sealant at jambs and head. Do not caulk at the window sill.
- Install flanged window. Install HydroFlash to the side jambs with a hand applicator. Surface should be clean and dry.
- Install drip cap. Apply HydroFlash header flashing with a hand applicator. Surface should be clean and dry.

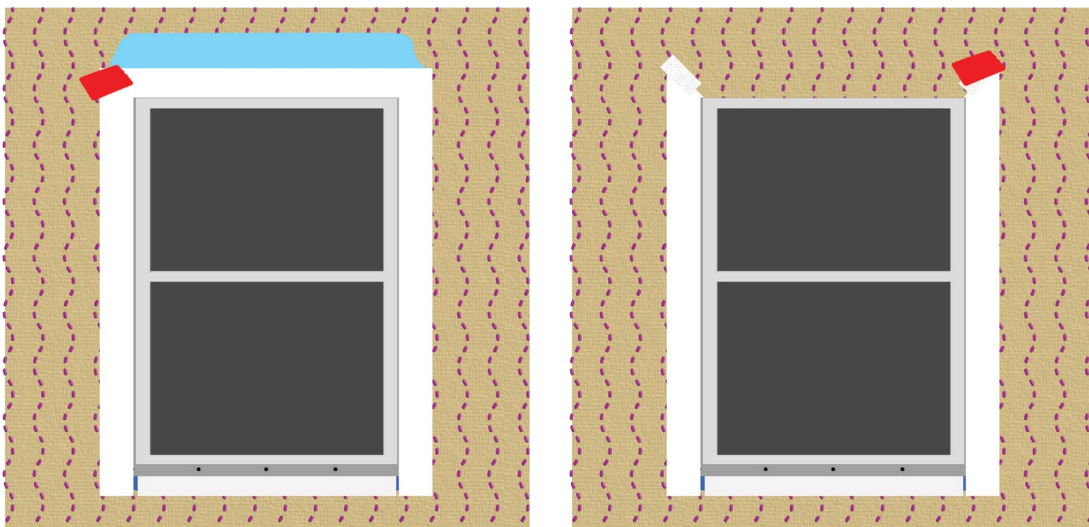

- Fold top flap down removing the adhesive backer. Using a roller or hand applicator, apply pressure to HydroGap® SA activating the acrylic adhesive over the head flashing.
- Apply HydroFlash® at the diagonal relief cuts.